

GENERAL NOTES :

CONVEYOR WEIGHT : 687 LB (without garment)
 APPROX. STORAGE CAPACITY : 732 GARMENTS

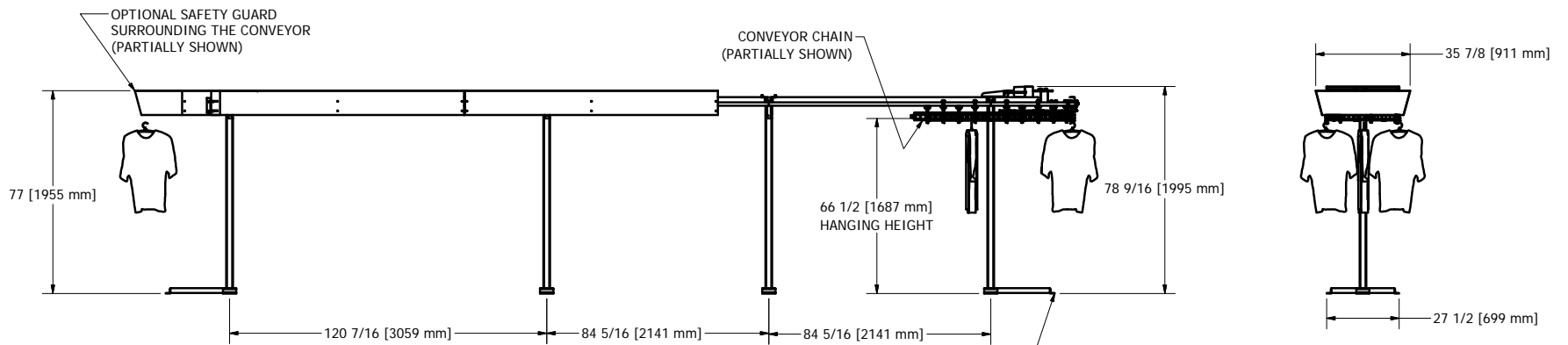
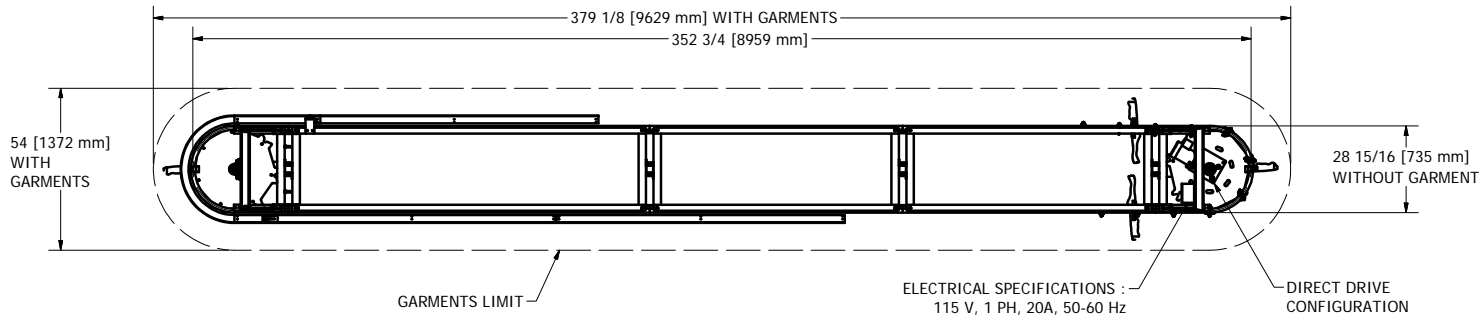
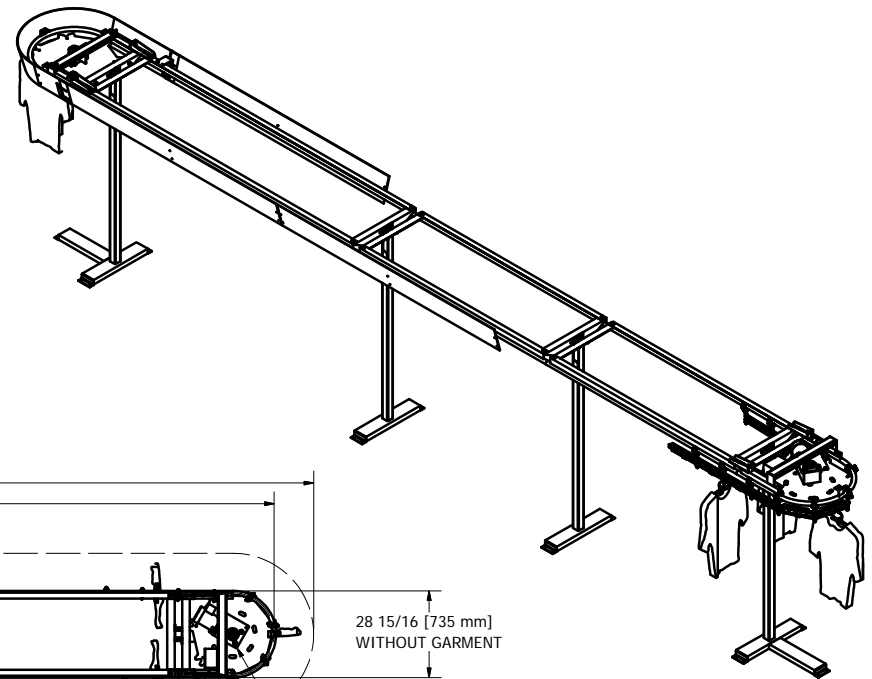

3/8" X 3-3/4 CONCRETE WEDGE ANCHORS REQUIRED (HILTI KB3 OR UCAN WED OR EQUIVALENT), 2-1/2" MINIMUM EMBEDMENT, TYP.

DESIGN F. ROULEAU	DATE 1/14/2010
DRAWN S. ROUS.-L.	DATE 1/14/2010
CHECKED	DATE
GENERAL TOLERANCES	
.X	+/- .030
.XX	+/- .010
.XXX	+/- .005
FRACTION	+/- 1/16

		www.planiform.com	
		TITLE GARMENT CONVEYOR	
SIZE C	DWG NO NPF-610	SCALE 3/8" = 1'-0"	REV