

GENERAL NOTES :

CONVEYOR WEIGHT : 701 LB (without garment)
 APPROX. STORAGE CAPACITY : 756 GARMENTS

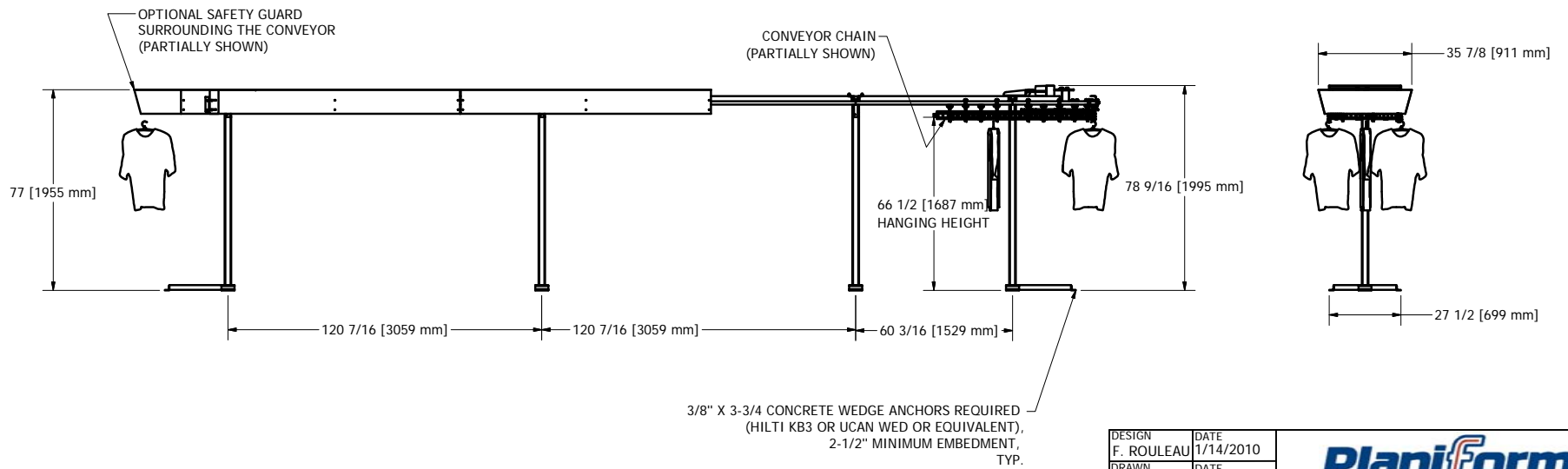
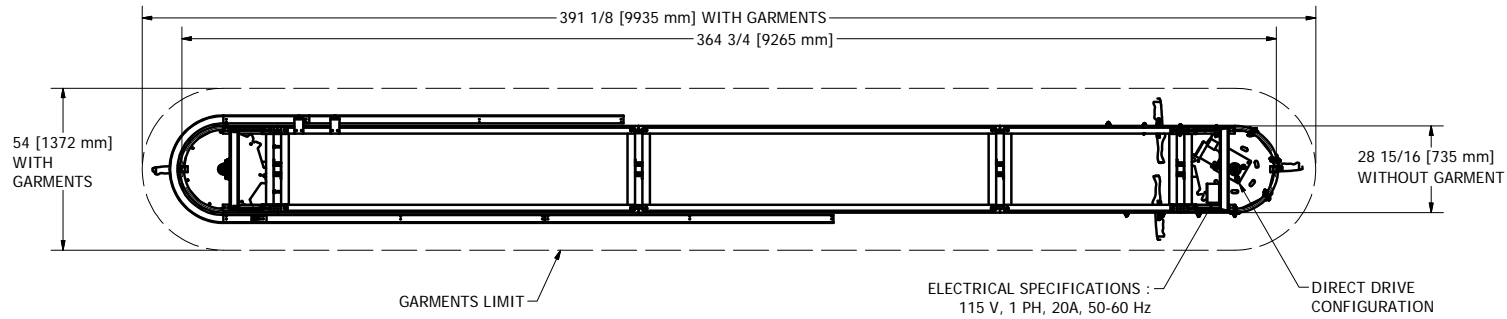
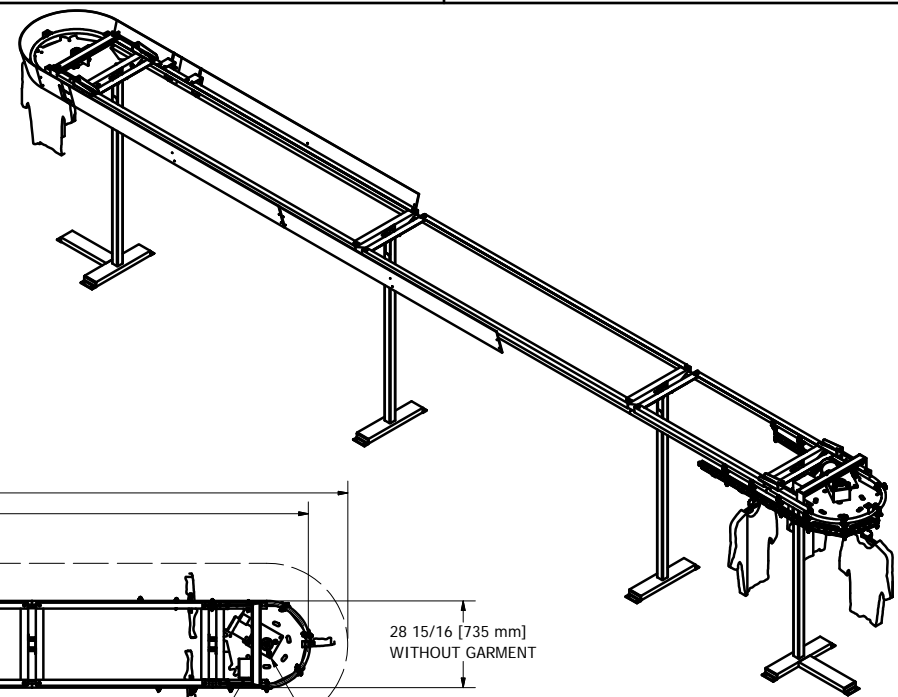

DESIGN F. ROULEAU	DATE 1/14/2010		
DRAWN S. ROUS.-L.	DATE 1/14/2010		
CHECKED	DATE	www.planiform.com	
GENERAL TOLERANCES		TITLE GARMENT CONVEYOR	
.X	+/- .030	SIZE DWG NO	SCALE
.XX	+/- .010	C NPF-630	3/8" = 1'-0"
.XXX	+/- .005		REV
FRACTION	+/- 1/16		